

Functional. By Design.

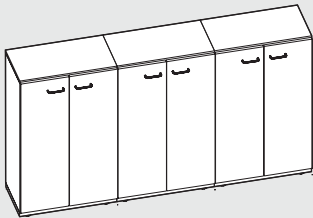

S1 72" x 39"

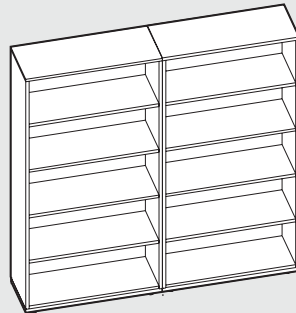

S4 64" x 66"

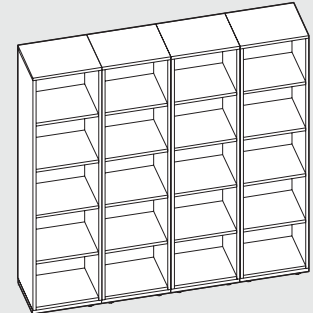

S7 64" x 66"

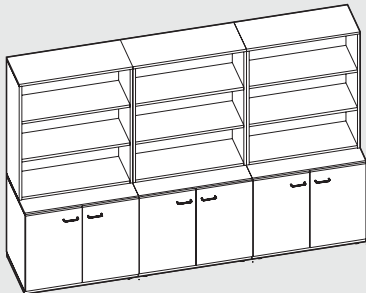

S2 96" x 67"

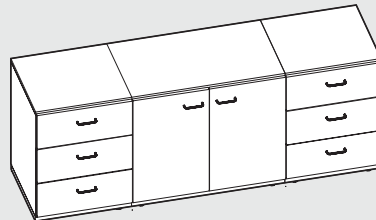

S5 104" x 28"

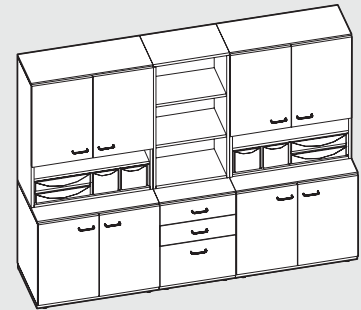

S8 84" x 67"

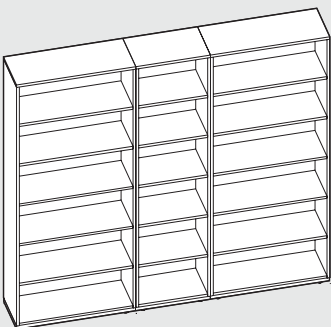

S3 84" x 78"

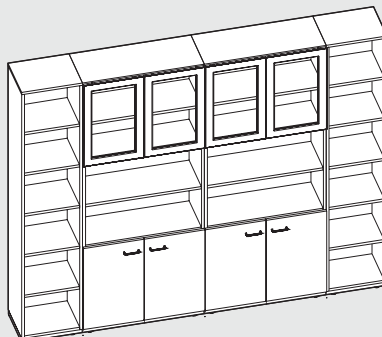

S6 96" x 78"

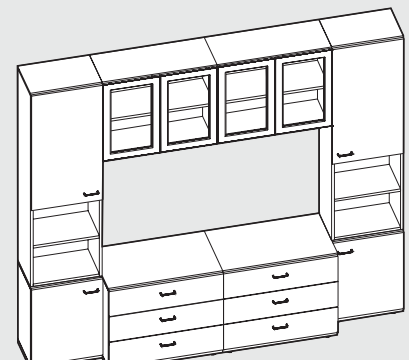

S9 104" x 78"

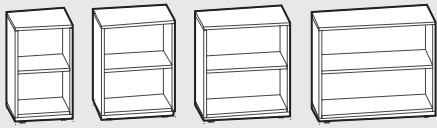

26"H x 14"D – Open Cabinets



Storage Configuration Ideas

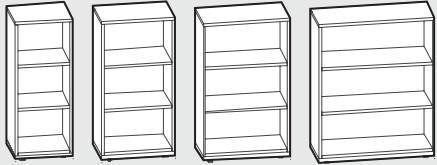

39"H x 14"D – Open Cabinets



Storage Configuration Ideas

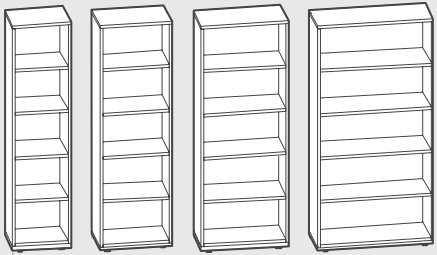

64"H x 14"D – Open Cabinets



Storage Configuration Ideas

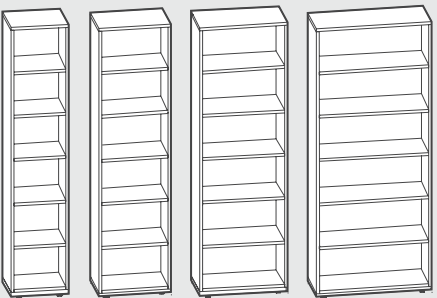

76"H x 14"D – Open Cabinets



Storage Configuration Ideas

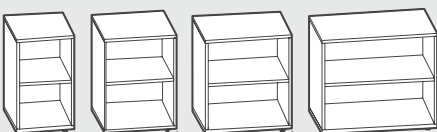

26"H x 20"D – Open Cabinets

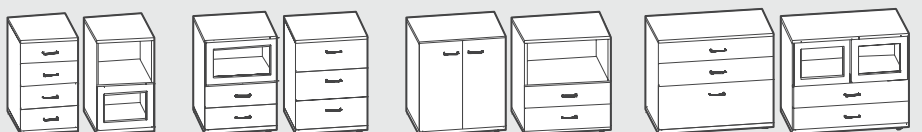

Storage Configuration Ideas